

ISDN

UM MODEL NO.:	SPECIFICATION	REV.	
UT21117	S _{2M} -Interface Transformer	A1	98/47

Characteristic data:

f=50KHz...3.1MHz
 RI=RII ≈ 0.15Ω
 RIII ≈ 0.4Ω
 Tu(amb)≤60°C

Schematic diagram:

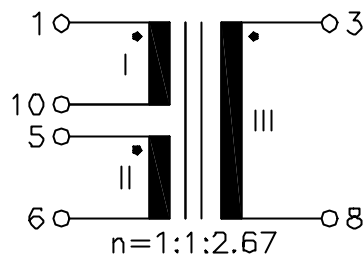

Electrical Specification at 25°C:

- 1.) LIII ≥ 5mH, at 10KHz 100mV
- 2.) Polarity and turns ratio tolerance ±5%
- 3.) Ls I=Ls II ≤ 0.25uH, (NIII shorted), at 100KHz 100mV
- 4.) HI-pot test:
 - Up=2.0KVrms, 3s(NIII to NI+NII)
 - Up=0.5KVrms, 3s(NI to NII)

Dimension:

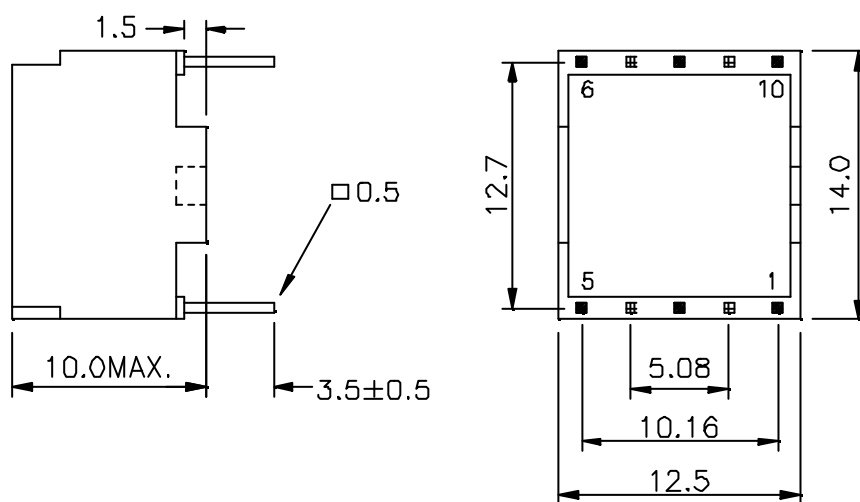

Note: Specifications are subject to change without prior notice.

UNIT: mm

Tolerances ±0.2mm



UNIVERSAL MICROELECTRONICS CO.,LTD.
 TEL:886-4-23590096 FAX:886-4-23590129
<http://www.umec-web.com> Email:business@umec.com.tw

3,27TH RD.,TAICHUNG INDUSTRIAL PARK,
 TAICHUNG,TAIWAN,R.O.C

E10-013-C